



INTERNATIONAL SAFETYNET HANDBOOK

Published by
Inmarsat Maritime Safety Services
Inmarsat Global Ltd
99 City Road
London, EC1Y 1AX
United Kingdom

SIXTH EDITION – APRIL 2020

Document History

5th Edition (PDF), January 2013

4th Edition (PDF), June 2004

3rd Edition (PDF), June 2000

2nd Edition (2, 2a, 2b, 2c) electronic 1996/1997

1st Edition printed only, July 1995

CONTENTS

1. FIGURE REFERENCES	1
2. PREFACE	2
3. WHAT IS MARTIME SAFETY INFORMATION (MSI)?	2
3.1. Three independent systems for broadcasting MSI	4
3.2. Scheduled and unscheduled MSI broadcasts	4
3.3. Language used for MSI broadcasts	5
4. NAVAREAS/METAREAS	5
5. INMARSAT OCEAN REGIONS	9
6. INMARSAT ENHANCED GROUP CALL (EGC) SERVICES	9
7. WHAT TYPES OF MSI CAN BE RECEIVED?	10
8. AVAILABILITY OF MSI IN DIFFERENT AREAS	11
9. REPEAT BROADCASTS OF MSI INFORMATION	14
10. SOLAS REQUIREMENTS FOR RECEIVING MSI BROADCASTS	14
11. TYPICAL MSI BROADCASTS	14
12. EGC RECEIVER TYPES	20
13. MANAGING YOUR INMARSAT C EGC RECEIVER	22
14. ADVISORY INFORMATION ON SES OPERATING PROCEDURES	22
15. REDUCE THE NUMBER OF ALARMS	23
16. MANDATORY MSI MESSAGES	23
17. ADDITIONAL RECOMMENDED MSI MESSAGES	24
18. GOOD OPERATING PRACTICE	24
19. REGULAR POSITION UPDATES	25
20. HOW TO SET UP AN EGC RECEIVER TO RECEIVE COASTAL WARNINGS	25
21. EGC SAFETYNET LOG	27
22. MANAGING THE INMARSAT FLEET SAFETY EGC RECEIVER	28
23. WHO TO CONTACT FOR ADVICE	32
ANNEX A – OPERATIONAL OVERVIEW OF SAFETYNET (II)	33
ANNEX B – SAFETYNET CONTACTS	35
ANNEX C – PERFORMANCE STANDARDS FOR EGC EQUIPMENT	36

1. FIGURE REFERENCES

- [Figure 1. Provision of Maritime Safety Information](#)
- [Figure 2 NAVAREAs Inmarsat C / Mini C](#)
- [Figure 3 METAREAs Inmarsat C / Mini C](#)
- [Figure 4 NAVAREAs Fleet Safety](#)
- [Figure 5 METAREAs Fleet Safety](#)
- [Figure 6 Inmarsat Enhanced Group Call \(EGC\) Services](#)
- [Figure 7. NAVAREA Warning with Safety priority, NAVAREA I](#)
- [Figure 8. NAVAREA Warning with Safety priority, NAVAREA III](#)
- [Figure 9. Weather Warning with Urgency priority, METAREA V](#)
- [Figure 10. METAREA Warning with Safety priority, METAREA I](#)
- [Figure 11. Coastal Warning with Safety priority](#)
- [Figure 12. Weather Warning with Safety priority](#)
- [Figure 13. Piracy Warning with Safety priority](#)
- [Figure 14. Search and Rescue \(SAR\) coordination message with Distress priority](#)
- [Figure 15. International Ice Patrol Warning with Safety priority, NAVAREA IV](#)
- [Figure 16. Class of Inmarsat C and Mini-C Ship Earth Stations](#)
- [Figure 17. Fleet Safety EGC Station](#)
- [Figure 18. General overview of EGC set-up screen](#)
- [Figure 19. General overview of EGC Log](#)
- [Figure 20 Fleet Safety MSI Pull \(i\)](#)
- [Figure 21 Fleet Safety MSI Pull \(ii\)](#)
- [Figure 22 Fleet Safety MSI Pull \(iii\)](#)
- [Figure 23 Fleet Safety MSI Pull \(iv\)](#)
- [Figure 24 Fleet Safety MSI Pull \(v\)](#)
- [Figure 25 International SafetyNET II service](#)

2. PREFACE

IMO SOLAS Chapter IV Regulation 12.2 states that “Every ship, while at sea, shall maintain a radio watch for broadcasts of maritime safety information on the appropriate frequency or frequencies on which such information is broadcast for the area in which the ship is navigating”.

This handbook is intended for mariners, to explain the operation of the International SafetyNET service as an element of the IMO Global Maritime Distress and Safety System (GMDSS). SafetyNET is the service for broadcasting and automatic reception of Maritime Safety Information (MSI) via Enhanced Group Call (EGC) system. Its receiving capability is part of the mandatory equipment to be carried by certain SOLAS compliant ships. EGC is the system for broadcasting messages via the Inmarsat satellite communications system and supports services: SafetyNET and SafetyNET II. This handbook deals mainly with the distribution of Maritime Safety Information (MSI) via satellite using the International SafetyNET services.

SafetyNET services provide the capability to address MSI to a given geographical area. The area may be fixed, such as IMO defined NAVAREAs and MEAREAs, coastal warning area, or it may be a user defined circular or rectangular area. MSI is submitted for broadcast using three priorities: Safety – Priority 1, Urgency – Priority 2 and Distress - Priority 3. Aboard ships, MSI messages are received automatically by Inmarsat C and Mini-C type-approved maritime terminals with EGC SafetyNET capability.

This handbook also explains how mariners can use SafetyNET services to obtain vital MSI tailored to the needs of the vessel.

More information about EGC SafetyNET and the GMDSS can be obtained by contacting one of the addresses given in [Annex A](#), or by visiting www.inmarsat.com/service/maritime-safety.

3. WHAT IS MARITIME SAFETY INFORMATION (MSI)?

MSI is defined by IMO as:

“Navigational and meteorological warnings, meteorological forecasts, and other urgent safety-related messages broadcast to ships”.

SafetyNET is defined by IMO as:

“The international service for the broadcast and automatic reception of Maritime Safety Information via the Inmarsat EGC system. The SafetyNET receiving capability is part of the mandatory equipment which is required to be carried by certain ships in accordance with the provisions of the international Convention for the Safety of Life at Sea, 1974, as amended”

The MSI service (Figure 1), is an internationally and nationally co-ordinated network of broadcasts containing information which is necessary for safe navigation from different MSI Providers, for example:

- National Hydrographic Offices, for navigational warnings and electronic chart correction data;
- National Meteorological Issuing Services, for weather warnings and forecasts;

- Rescue Co-ordination Centres (RCCs), for shore-to-ship distress alerts, Search and Rescue (SAR) coordination and other urgent information; and
- The International Ice Patrol, for North Atlantic ice hazards.

Only approved MSI Providers are authorised to make SafetyNET broadcasts. Approval is requested:

- Meteorological authorities – to WMO
- Hydrographic authorities – to IHO
- Search and Rescue authorities – to IMO
- The International Ice Patrol – to IMO
- Other – to IMO

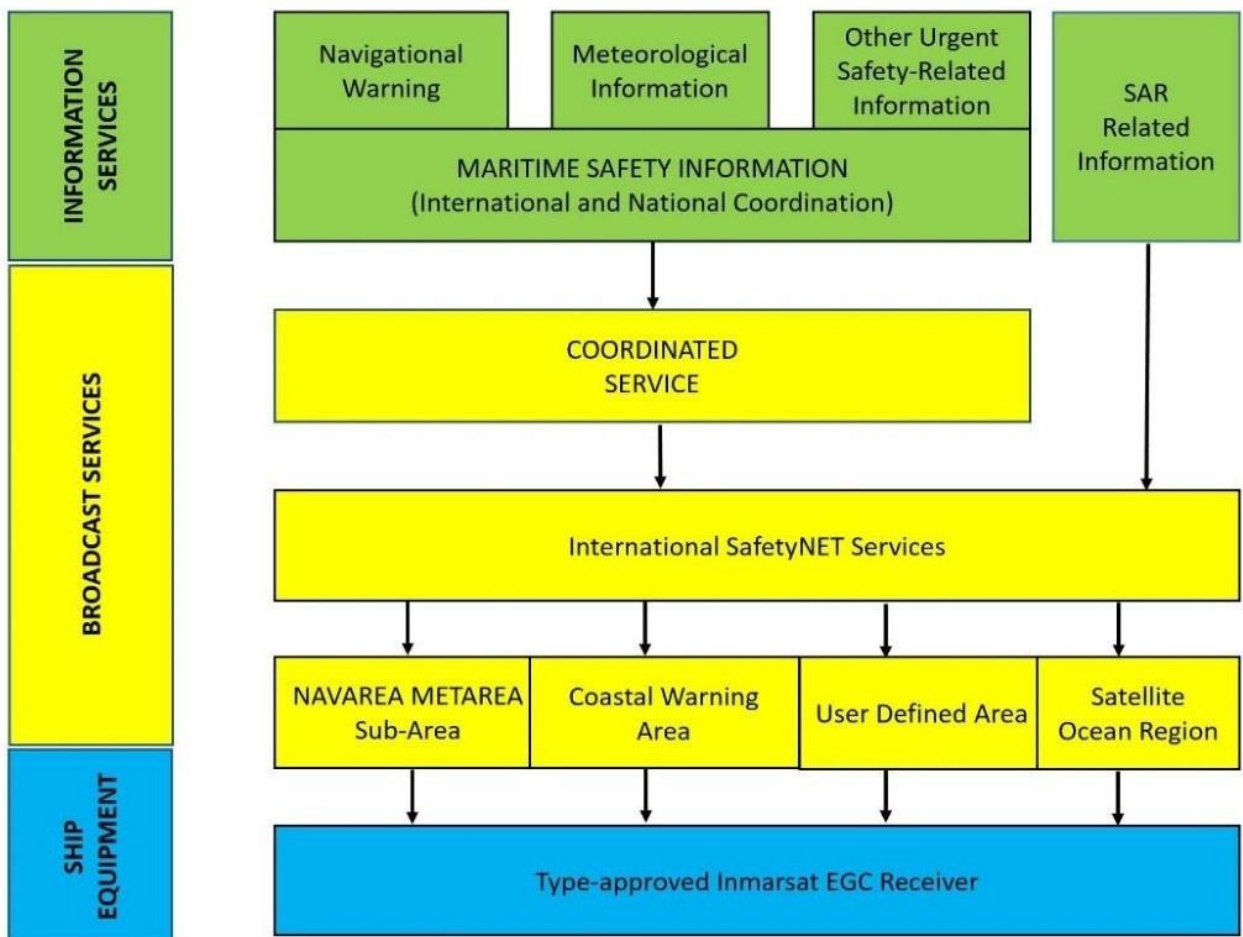

Figure 1. Provision of Maritime Safety Information

Please note the following point about the SafetyNET service:

Inmarsat Global Ltd. is not an Information Provider but provides Inmarsat C and Fleet Safety satellite communications system used for MSI broadcast and reception. Reception of MSI broadcasts is free of charge to all ships.

3.1. Three independent systems for broadcasting MSI

3.1.1. The International NAVTEX Service, whereby the Information Provider forwards the MSI for a given area to a 518 kHz MF NAVTEX transmitter. Note that reception of NAVTEX MSI is limited by the range of the MF propagation to the coastal area around the transmitter. This is not a service provided by Inmarsat.

3.1.2. The International SafetyNET Service, whereby the Information Provider transmits the MSI, for a given area, to an Inmarsat Land Earth Station (LES), for broadcasting via the Network Control Station and satellite network to an entire Inmarsat Ocean Region(s); consequently, ships can receive SafetyNET MSI anywhere in the Ocean Region(s), irrespective of their distance from the LES or MSI Provider.

The International SafetyNET II Service is an enhancement to the International SafetyNET Service, whereby the Information Provider promulgates the MSI on the interactive SafetyNET II web interface portal and broadcasts direct to the Network Control Station, Satellite Access Station and satellite network to an entire Inmarsat Ocean Region(s); consequently, ships can receive SafetyNET II MSI anywhere in the Ocean Region(s), irrespective of their distance from the LES or MSI Provider.

The use of SafetyNET or SafetyNET II has no consequence to the vessel, both SafetyNET and SafetyNET II messages are received on Inmarsat EGC capable receivers such as Inmarsat C, Mini C and Fleet Safety.

As indicated in Figure 1, MSI for a given area is generally broadcast over either NAVTEX or SafetyNET (except for some circumstances where a message may be broadcast using both services); ships equipped with both NAVTEX receiver and SafetyNET receiver, if they are properly configured, will automatically receive MSI for the addressed area where the ship is navigating. Where a coastal area is not covered by the international or national NAVTEX service, for example around Australia, MSI for that area is broadcast on SafetyNET services only.

To find out which MSI service, NAVTEX or SafetyNET serves a particular area, a user should refer to the current Lists of Radio Signals publication for that area, obtainable from national administrations.

3.2. Scheduled and unscheduled MSI broadcasts

To ensure that the user knows when to receive required MSI for a given area, many MSI broadcasts are scheduled, under IMO co-ordination, at a particular time and nominated satellite. For example, all navigational warnings and meteorological forecasts are scheduled broadcasts, while some MSI, for example, severe meteorological warnings, shore-to-ship distress alerts, SAR coordination communication are unscheduled broadcasts and are usually given urgency or distress priority that produces an audible and visual alarm on the EGC receiver.

Information on scheduled broadcasts for both NAVTEX and SafetyNET is given in current Lists of Radio Signals, available from national administrations and shown in Table 2 and 3

To be sure of receiving a scheduled MSI broadcast, the receiver MUST be tuned to the appropriate or nominated satellite/Ocean Region at the time of transmission. For Inmarsat C and Mini C terminals, this is done by "logging-in" to the appropriate ocean region satellite. There is no reason to change satellite for Fleet Safety terminals, as this is automated through the Inmarsat network. Unscheduled SafetyNET broadcasts are

made over all satellites covering an area, so the receiver will not miss the message, no matter what satellite it is logged in to. The user is advised of the receipt of an unscheduled distress or urgency broadcast by the EGC receiver alarming.

3.3. Language used for MSI broadcasts

All MSI broadcasts made on the International SafetyNET services are broadcast in English, sometimes a local language is added after the English wording.

4. NAVAREAS/METAREAS

Figure 2 NAVAREAs with Inmarsat C / Mini C coverage

Figure 2 METAREAs with Inmarsat C / Mini C coverage

Figure 3 NAVAREAs with Fleet Safety coverage

Figure 4 METAREAs with Fleet Safety coverage

For each area, a NAVAREA co-ordinator or METAREA issuing service co-ordinates broadcast of navigational warnings and meteorological information throughout their area respectively.

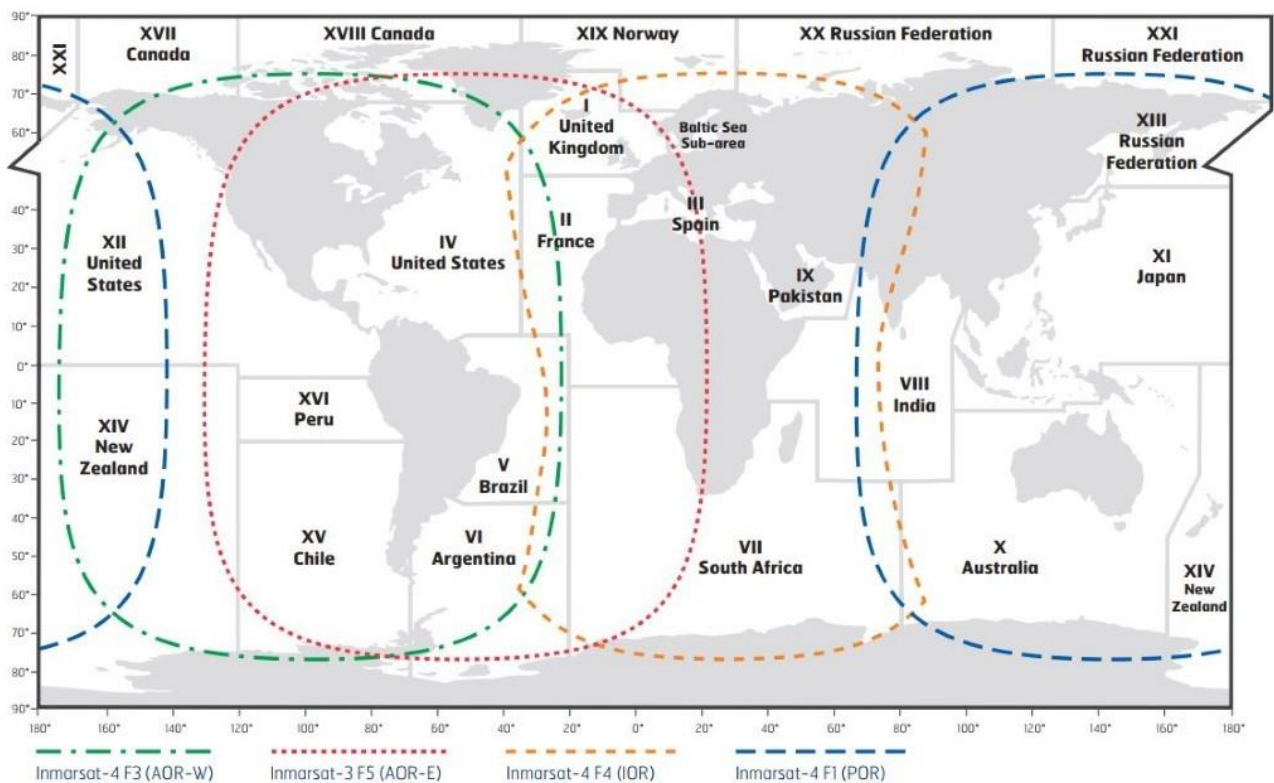

This map depicts Inmarsat's expectations of coverage. It does not represent a guarantee of service. The availability of service at the edge of coverage areas fluctuates depending on various conditions.
© Inmarsat Global Limited 2019.

Figure 2 NAVAREAs Inmarsat C / Mini C

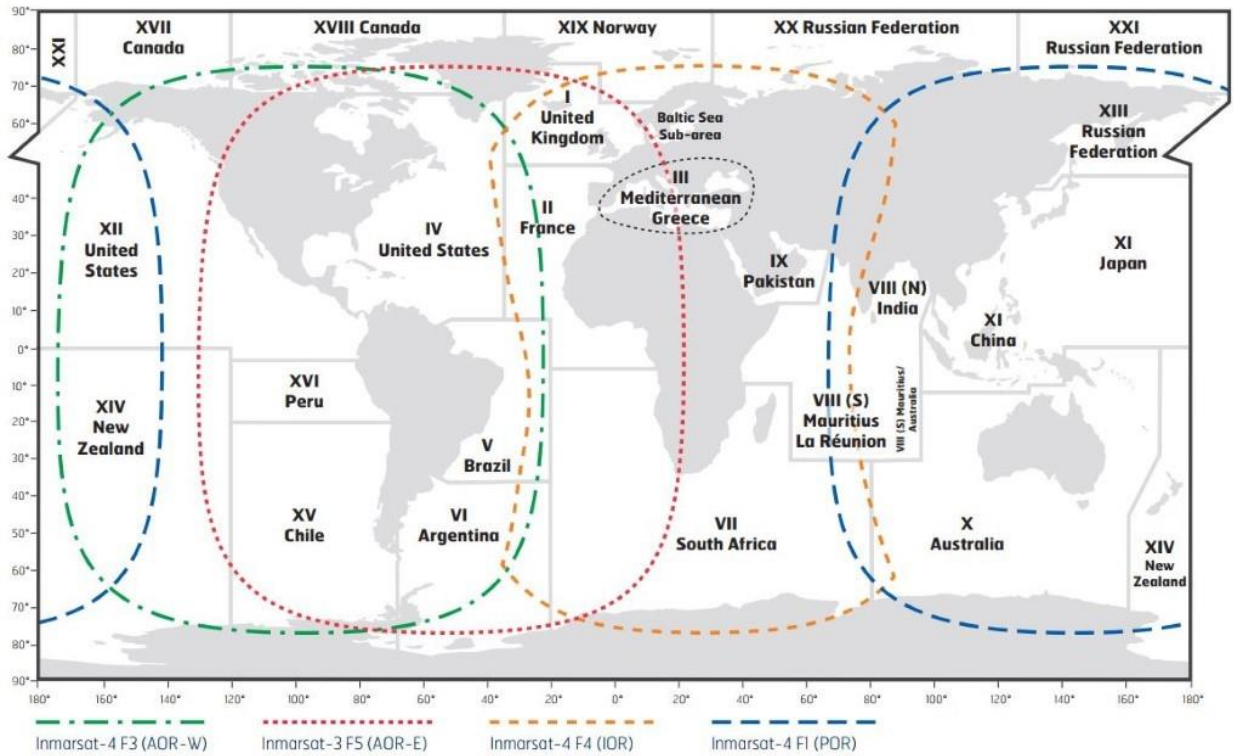
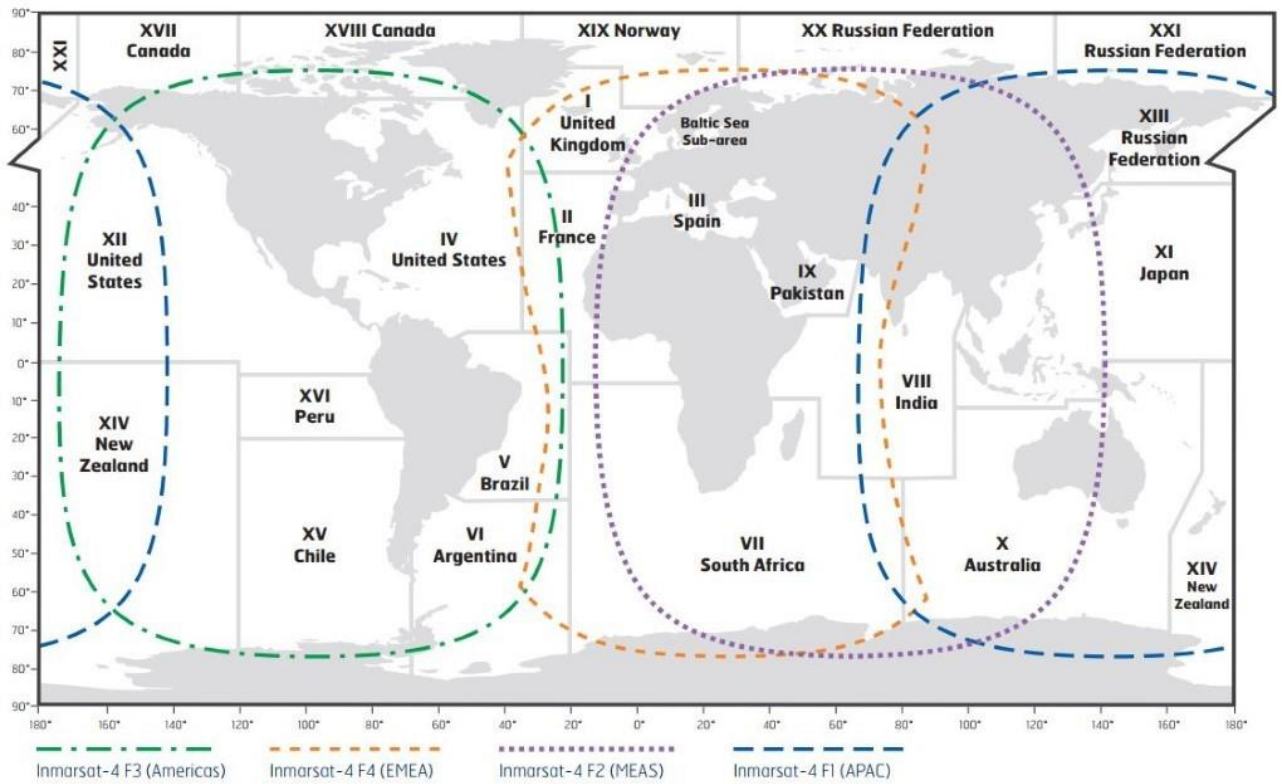
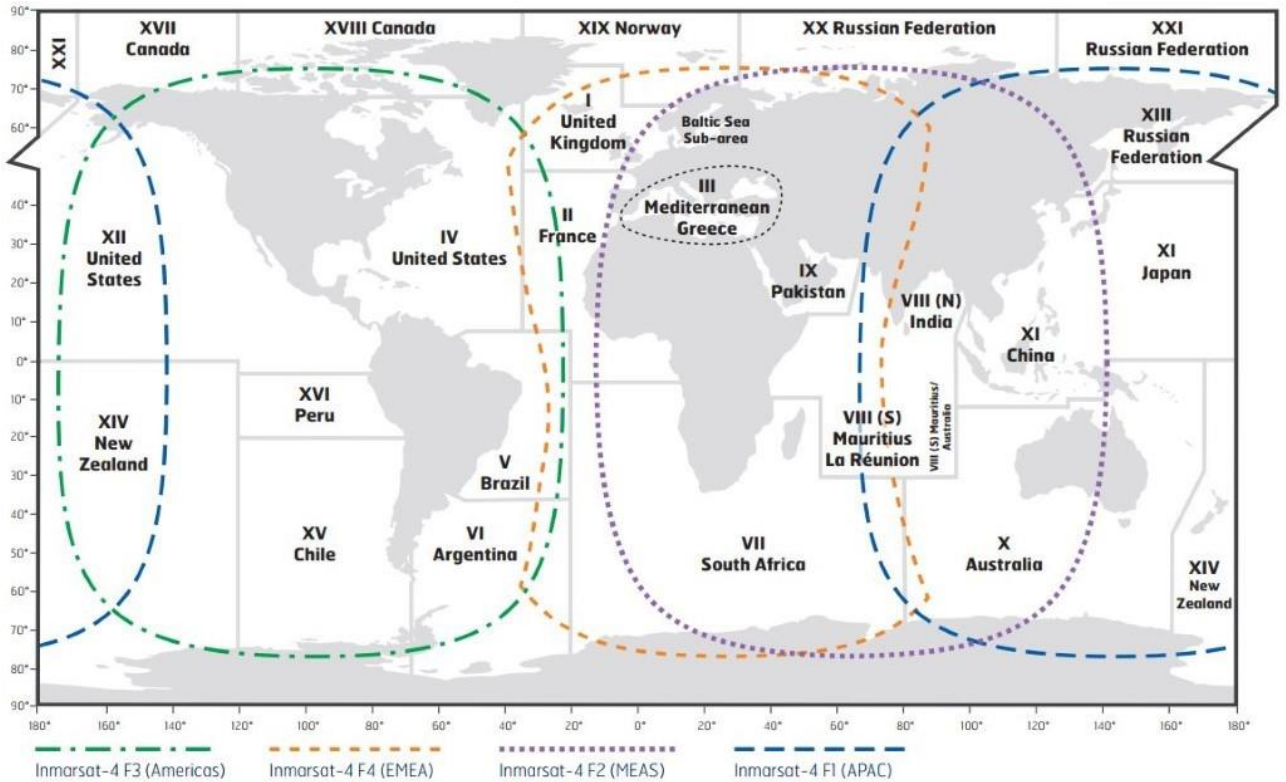

Figure 3 METAREAs Inmarsat C / Mini C



This map depicts Inmarsat's expectations of coverage following the commercial introduction of Inmarsat's fourth L-band region. It does not represent a guarantee of service. The availability of service at the edge of coverage areas fluctuates depending on various conditions. © Inmarsat Global Limited 2019.

Figure 4 NAVAREAs Fleet Safety



This map depicts Inmarsat's expectations of coverage following the commercial introduction of Inmarsat's fourth L-band region. It does not represent a guarantee of service. The availability of service at the edge of coverage areas fluctuates depending on various conditions. © Inmarsat Global Limited 2019.

Figure 5 METAREAs Fleet Safety

5. INMARSAT OCEAN REGIONS

The above figures show the Inmarsat satellites used for Inmarsat C / Mini C and Fleet Safety. Inmarsat uses a mesh network of satellites to provide optimal coverage for all Inmarsat GMDSS services. The tables below show the satellite name and corresponding sea areas for each service:

SATELLITE	INMARSAT C OCEAN REGION
3-F5	AOR-E (Atlantic Ocean Region East)
4-F3	AOR-W (Atlantic Ocean Region West)
4-F1	POR (Pacific Ocean Region)
4-F4	IOR (Indian Ocean Region)

SATELLITE	FLEET SAFETY OCEAN REGION
4-F3	AMER (Americas)
4-F1	APAC (Asian Pacific)
4-F4	EMEA (Europe Middle East & Africa)
4-F2	MEAS (Middle East & Asia)

Table 1 Inmarsat Ocean Regions

6. INMARSAT ENHANCED GROUP CALL (EGC) SERVICES

Inmarsat C, Mini C and Fleet Safety satellite communications systems have the EGC capability, which enables MSI providers to send messages for selective reception by EGC receivers located anywhere in the four Ocean Regions.

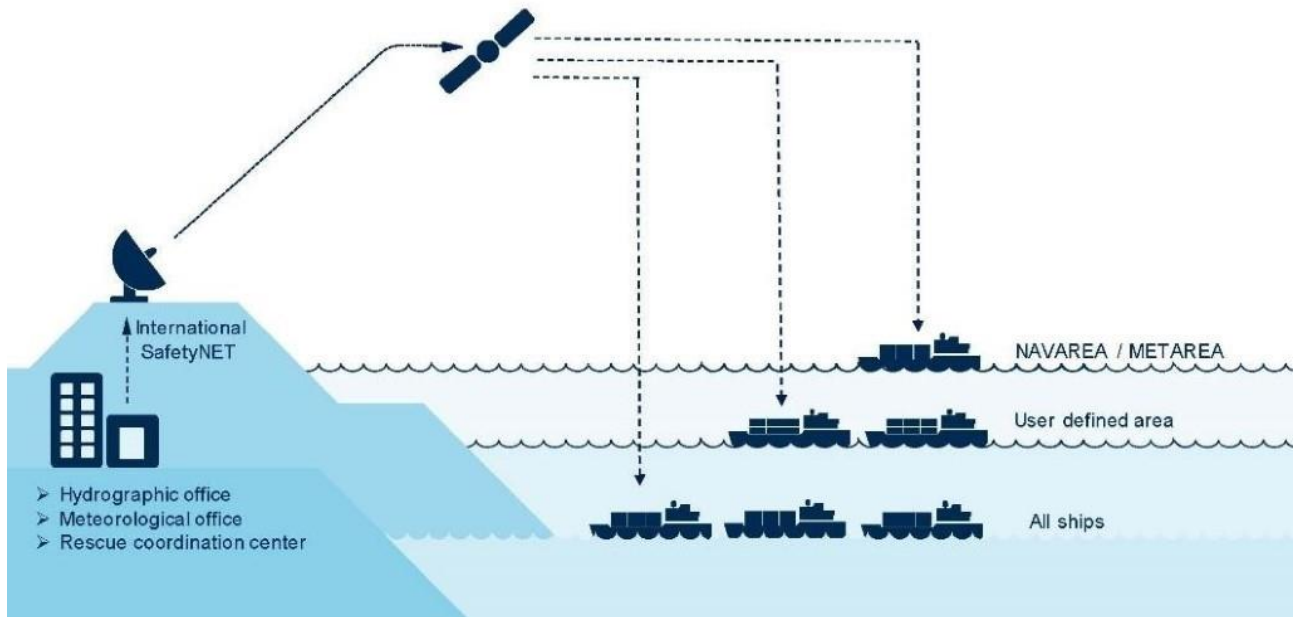

Figure 6 Inmarsat Enhanced Group Call (EGC) Services

The MSI provider determines in which area vessels will receive the message by including identifying information, such as the NAVAREA or METAREA number, circular or rectangular coordinates, coastal warning area, if the terminal is in this area it will receive the broadcast, if not in the area, it will not be received.

On some Inmarsat C / Mini C models, identification of NAVAREA/METAREA where the ship is navigating is done automatically, some older terminals require this information input manually, please check your user manual for instructions. EGC receivers can be setup to receive broadcasts from additional adjacent NAVAREAs and METAREAs.

Each EGC receiver automatically receives mandatory broadcasts, such as NAVAREA Warnings and SAR Broadcasts. It is possible to select additional EGC message types, such as Ice Warnings.

7. WHAT TYPES OF MSI CAN BE RECEIVED?

Below is a list of the different types of MSI that can be received (subject to availability).

- All ships (general call – mainly used by Inmarsat to broadcast service announcements);
- NAVAREA/METAREA warning, MET forecast or Piracy warnings to NAVAREA or METAREA;
- Navigational, Meteorological or Piracy warnings to a circular or rectangular area;
- Search and Rescue coordination to ships to a circular or rectangular area;
- Shore-to-ship distress alerts to a circular area;
- Coastal warnings include the following type of messages:
 - Navigational warnings;
 - Meteorological warnings;
 - Ice reports;
 - Search and rescue information, acts of piracy warnings, tsunami and other natural phenomena;

- Meteorological forecasts;
- Pilot and VTS service messages;
- AIS service messages (non navigational aid)
- LORAN system messages;
- GNSS messages;
- Other electronic navigational aid messages;
- Other navigational warnings (additional to standard? navigational warnings);
- No messages on hand

Notes:

1. *The SafetyNET coastal warning broadcast is (usually) made available for the transmission of MSI for areas where NAVTEX services are not provided.*
2. *Detailed information how to set up EGC receivers to receive coastal warnings is provided in the relevant section on page 25.*

8. AVAILABILITY OF MSI IN DIFFERENT AREAS

To avoid excessive duplication of broadcasts, the IMO has authorised the following arrangements:

For a given NAVAREA/METAREA which is covered by more than one Ocean Region satellite, scheduled broadcasts of MSI, such as navigational warnings and meteorological information, are made only via a single nominated satellite/Ocean Region. For a NAVAREA/METAREA which is covered by more than one Ocean Region satellite, unscheduled broadcasts of MSI, such as gale warnings, distress alert relays, search and rescue coordination are made via all satellites/Ocean Regions which cover the area concerned. In addition, the vessel operator should ensure that position information on their Inmarsat C or Mini C terminal (EGC receiver) is updated regularly if not done automatically. This can be checked on the position menu on the terminal. Modern SESs have an integrated GNSS receiver and the ships position is updated automatically every few seconds. A manual update will be required on some older models without automatic positioning. If the position information on the terminal is not valid, the terminal will receive all EGC messages via the satellite connection, which may result in receiving (and printing) numerous unwanted messages.

METAREA Warning Schedules

METAREA	ISSUING COUNTRY	TIMES (UTC)	SATELLITE
I	United Kingdom	0930, 2130	AOR (E)
II	France	1015, 2215	AOR (E) & (W)
III	Greece	1000, 2200	AOR (E)
IV	United States	0430, 1030, 1630, 2230	AOR (E) & (W)
V	Brazil	0730, 1930	AOR (E)
VI	Argentina	0230, 1730	AOR (W)
VII	South Africa	0940, 1940	AOR (E) & IOR
VIII	India	0900, 1800 (for North of equator)	IOR
	Mauritius/La Réunion	0130, 1330 (for South of equator)	
IX	Pakistan	0630, 0700, 1830	IOR
X	Australia	1030, 2330 (for coastal areas see Annex 8, page 3, MET Area X)	IOR
		1100, 2300 (for coastal areas see Annex 8, page 3, MET Area X)	POR
XI	China	1015, 2215	IOR
	Japan	0230, 0830, 1430, 2030	POR
XII	United States	0545, 1145, 1745, 2345	POR & AOR (W)
XIII	Russian Federation	0930, 2130	POR
XIII	Japan*	0230, 0830, 1430, 2030 (for South of 60° N)	
XIV	New Zealand	0930, 2130 0100, 1300 (NZ Coast only) 0330, 1530 (Warnings only))	POR
XV	Chile	0100, 0345, 1330, 1440, 1845	AOR (W)
XVII	Canada	0300, 1500	POR
XVIII	Canada	0300, 1500	AOR (W)
XIX	Norway	1100, 2300	AOR-E
XX	Russian Federation	0600, 1800	IOR
XXI	Russian Federation	0600, 1800	POR

Table 2. Illustrating the availability of Meteorological MSI in all areas and nominated satellites as of July 2016.
* Same service to METAREA XI.

NAVAREA Warning Schedules

NAVAREA	COORDINATOR	TIMES (UTC)	SATELLITE
I	United Kingdom	0530, 1730	AOR-E
II	France	0430, 1630	AOR-E
III	Spain	1200, 2400 + on receipt	AOR-E
IV	United States	1000, 2200	AOR-E & (W)
V	Brazil	0030, 1230	AOR-E
VI	Argentina	0200, 1400	AOR (W)
VII	South Africa	0940, 1940	IOR & AOR-E
VIII	India	1000, 2200	IOR
IX	Pakistan	0300, 1500	IOR
X	Australia	0700, 1900	POR & IOR
XI	Japan	0005,1205	POR & IOR
XII	United States	1030, 2230	POR & AOR (W)
XIII	Russian Federation	0930, 2130	POR
XIV	New Zealand	0900, 2100	POR
XV	Chile	0210, 1410	AOR (W)
XVI	Peru	0500, 1700	AOR (W)
XVII	Canada	1130, 2330	POR
XVIII	Canada	1100, 2300	AOR (W)
XIX	Norway	0630, 1830	AOR-E
XX	Russian Federation	0530,1730	IOR
XXI	Russian Federation	0630,1830	POR

Table 3. Illustrating the availability of Navigational MSI in all areas and nominated satellites as of July 2016.

Note: this information is subject to change; to obtain latest information you should refer to a current publication of Lists of Radio Signals, available from national administrations.

The IMO has decided the scheduled broadcasts of navigational warnings and meteorological forecasts will be made at times illustrated in Tables 2 and 3 over a single nominated satellite for each NAVAREA/METAREA. Unscheduled broadcasts of severe weather warnings, distress alert relays, search and rescue coordination will be made over all satellites which serve the area concerned.

Note: Fleet Safety terminals are not required to change satellite for reception of EGC. EGC messages selected for reception will be received automatically, irrespective of the satellite being used.

9. REPEAT BROADCASTS OF MSI INFORMATION

Some older classes of Inmarsat C and Mini C maritime terminals with EGC receivers, do not provide uninterrupted monitoring of the channel used for MSI broadcasts when involved in normal communication traffic. These terminals have a single receiver for both MSI and incoming commercial traffic. See section “EGC receiver types” on page 20 for more details.

To improve the probability of these terminals receiving MSI broadcasts, Information Providers re-broadcast some messages:

- Unscheduled messages, such as distress alerts and gale warnings are usually rebroadcast six minutes after the initial broadcast;
- Scheduled broadcasts, such as navigational warnings and other longer-term information are repeated at the scheduled time, for as long as they remain in force. (Repeated broadcasts of the same message may cause users to receive and print too many messages - for advice consult the set-up instructions from the terminal manufacturer).

10. SOLAS REQUIREMENTS FOR RECEIVING MSI BROADCASTS

Every SOLAS compliant ship shall meet the following legal requirements for receiving MSI broadcasts:

- Watches - every ship while at sea, shall maintain a radio watch for broadcasts of MSI on the appropriate frequency or frequencies on which such information is broadcast for the area in which the ship is navigating (SOLAS Convention, Chapter IV, Regulation 12.2).

In addition to these mandatory requirements, the IMO recommends that all current navigational and meteorological messages be retained on the bridge, for as long as they are applicable, for the use of the person in charge of the navigational watch.

11. TYPICAL MSI BROADCASTS

Figures 6 - 14 show typical MSI broadcasts of different types and which type of broadcast can be received on Inmarsat C, Mini-C and Fleet Safety terminals. Please note that the format of the message header may be different depending on the terminal model.

Note the following:

1. MSI may be broadcast with a keyword in their header, indicating the priority of the message - DISTRESS or MAYDAY for Priority 3, URGENT or PAN PAN for Priority 2, and SAFETY or SECURITE for Priority 1;
2. The date and time of the message in UTC;
3. The priority of the message – Safety, Urgency or Distress is given in the message header. The terminal responds automatically to Urgency and Distress priority messages by giving an audible/visual alarm and automatic message printing.
4. The term PosOK in Figures below, that some Inmarsat C and Mini C models include in the message header, tells the operator that the EGC receiver has been updated with the ship's position within the last 4 hours and position is valid. Otherwise the indicator will change to NoPos.

LES 102 - MSG 7698 - MetWarn/For Safety Call to Area: 1 - NoPos
STRATOS CSAT 81.148.5.74 1-OCT-2019 05:44:00 606085
NAVAREA ONE 044
ENGLAND, EAST COAST
Thames Estuary.
Chart BA 1975.
Black Deep light-buoy moved to 51-47.79N 001-36.31E.
NNNN

Figure 7. NAVAREA Warning with Safety priority, NAVAREA I

LES 112 - MSG 9644 - MetWarn/For Safety Call to Area: 3 - PosOK
NL BURUM LES 204999123456789 28-SEP-2019 12:21:01 618223
NAVAREA III 068/12
EASTERN MEDITERRANEAN SEA
Offshore rig "OCEAN ENDEAVOR" moved from 32-05.1N 030-36.5E to 32-04.1N
030-29.4E

Figure 8. NAVAREA Warning with Safety priority, NAVAREA III

LES 112 - MSG 11400 - MetWarn/For Urgent Call to Area: 5 - PosOK
NL BURUM LES 28-SEP-2019 15:36:29 831346
WARNING NR 074/2011
ROUGH SEA WARNING
ISSUED AT 1500 GMT - MON - 28/SEP/2018
SOUTH OCEANIC AREA S OF 30S AND E OF 035W STARTING AT 010000 GMT.
WAVES FM NE/NW BECOMING SW/SE 3.0/4.0 METERS.
VALID UNTIL 020600 GMT.

Figure 9. Weather Warning with Urgency priority, METAREA V

LES 112 - MSG 11497 - MetWarn/For Safety Call to Area: 1 – NoPos

NL BURUM LES 1-NOV-2019 09:25:35 997803

SECURITE

HIGH SEAS BULLETIN FOR METAREA 1 ISSUED AT 0800 UTC 01 NOVEMBER 2012 BY THE MET OFFICE, EXETER, UNITED KINGDOM FOR THE PERIOD 0800 UTC 01 NOVEMBER UNTIL 0800 UTC 02 NOVEMBER 2012

STORM WARNING

AT 010000UTC, LOW 51 NORTH 39 WEST 1006 EXPECTED 63 NORTH 20 WEST 982 BY 020000UTC. WINDS ARE EXPECTED TO REACH STORM FORCE 10 BETWEEN 50 AND 300 MILES OF THE CENTRE IN THE EASTERN, SOUTHERN AND WESTERN QUADRANTS FROM 011500UTC, PERHAPS VIOLENT STORMFORCE 11 FROM 012200UTC

GENERAL SYNOPSIS

AT 010000UTC, LOW 51 NORTH 39 WEST 1006 EXPECTED 63 NORTH 20 WEST 982 BY 020000UTC. LOW 66 NORTH 34 WEST 982 EXPECTED 66 NORTH 32 WEST 995 BY SAME TIME. HIGH 52 NORTH 08 WEST 1038 EXPECTED 57 NORTH 05 EAST 1043 BY THAT TIME AREA FORECASTS

FOR THE NEXT 24 HOURS

WEST SOLE

VARIABLE 4, BECOMING SOUTHEASTERLY 4 OR 5 FOR A TIME. MODERATE OR ROUGH. MAINLY FAIR. GOOD

EAST SOLE

NORTHEASTERLY 4 OR 5. MODERATE OR ROUGH. FAIR. GOOD

SHANNON ...

ROCKALL ...

BAILEY ...

FAEROES SOUTHEAST ICELAND ...

EAST NORTHERN SECTION ...

WEST NORTHERN SECTION ...

EAST CENTRAL SECTION ...

WEST CENTRAL SECTION ...

DENMARK STRAIT ...

NORTH ICELAND ...

NORWEGIAN BASIN ...

OUTLOOK FOR FOLLOWING 24 HOURS:

STORMS OR VIOLENT STORM EXPECTED IN BAILEY, FAEROES, SOUTHEAST ICELAND, EAST NORTHERN SECTION, NORTH ICELAND AND NORWEIGIAN BASIN. SEVERE GALES EXPECTED IN ROCKALL AND WEST NORTHERN SECTION. GALES OR SEVERE GALES EXPECTED IN WEST CENTRAL SECTION AND DENMARK STRAIT

**UNSCHEDULED STORM WARNINGS ARE BROADCAST VIA SAFETYNET(II) AND
IN BULLETIN WONT54 EGRR AVAILABLE VIA SOME INTERNET AND FTPMAIL**

Figure 10. METAREA Warning with Safety priority, METAREA I

LES 321 - MSG 16362 - CoastalWarn Safety Call to Area: 8 D A – PosOK

**LES21 FRANCE TELECOM 20890000006 5-NOV-2019 00:41:55 551725
THIS IS MRCC REUNION (REUNION ISLAND)
PHONE: +262 262 43 43 43
FAX: +262 262 71 15 95
TELEX: 916 140F
INMARSAT: 422 799 193
HF SSB: 8291 KHZ**

SECURITE

COAST WARNING LA REUNION 23/12

**INDIAN OCEAN - SOUTH WEST SECTOR REUNION
ONE FISHING CONCENTRATION DEVICE (DCP) HAS BEEN MOORED THE 25
OCTOBER 2012 IN THE NORTH WEST OF RENION ISLAND TO THE INDICATED
POSITION: 2102.444S-05503.509E (WGS 84).
CAUTION ADVISED.**

**ONE FISHING CONCENTRATION DEVICE (DCP) HAS BEEN MOORED THE 25
OCTOBER 2018 IN THE NORTH WEST OF RENION ISLAND TO THE INDICATED
POSITION: 2057.624S-05504.780E (WGS 84).
CAUTION ADVISED.**

Figure 11. Coastal Warning with Safety priority

(Navigational warning - "A" addressed to Coastal warning area "D" inside NAVAREA VII)

LES 312 - MSG 11517 - Met/NavWarn Safety Call to Area: 38 S 134 E 999 PosOK

NL BURUM LES 204988123456789 1-NOV-2019 11:55:08 021178

SECURITE

**HIGH SEAS WEATHER WARNING FOR METAREA 10 ISSUED BY THE
AUSTRALIAN BUREAU OF METEOROLOGY, ADELAIDE AT 1154UTC 1.11.2019.**

GALE WARNING FOR SOUTH EASTERN AREA

PLEASE BE AWARE

Wind gusts can be 40 percent stronger than the averages given here, and maximum waves may be up to twice the height.

SITUATION AT 011130UTC

Vigorous west to southwest airstream.

AREA AFFECTED

Area bounded by 45S129E 42S141E 50S141E 50S129E 45S129E.

FORECAST

W/SW winds 30/40 knots. Rough to very rough seas. Moderate to heavy swell.

WEATHER ADELAIDE

Figure 12. Weather Warning with Safety priority

(Addressed to a circular area with the centre of the circle at 38°S 164°E and radius 999 nautical miles)

LES 328 - MSG 3487 - NavWarn Safety Call to Area: 30+60 S 20+120 E – PosOK

**FROM 165.21.245.44 29-OCT-2019 13:52:18 MSG787929 SENTOSA C LES
291345 UTC OCT 2019**

TO: ALL SHIPS TRANSITING OFF SOMALIA / OFF KENYA / OFF TANZANIA

WARNING WARNING WARNING

**ON 29.10.2018 AT 1300 UTC IN POSITION 04:29S - 039:57E, OFF MOMBASSA,
KENYA. A MERCHANT VESSEL WAS UNDER ATTACK BY 2 SKIFFS AND THE
VESSEL HAS EVADED THE ATTACK.**

**VESSELS ARE ADVISED TO EXERCISE EXTREME CAUTION WHEN
NAVIGATING WITHIN 100 NAUTICAL MILES OF THE POSITION GIVEN IN THIS
REPORT AND MAINTAIN MAXIMUM CPA WITH ANY SHIP ACTING
SUSPICIOUSLY.**

**EARLY ASSESSMENT / DETECTION WILL ALLOW SHIPS TO TAKE
EVASIVEMEASURES TO PREVENT BOARDING AND REQUEST FOR
ASSISTANCE.**

**ALL ATTACKS AND SUSPICIOUS SIGHTINGS INCLUDING POSSIBLE
PIRATE MOTHER VESSEL TOWING SKIFFS SHOULD BE REPORTED**

**IMB PIRACY REPORTING CENTRE
24 HOURS ANTI-PIRACY HELPLINE: +603 2031 0014
EMAIL: piracy@icc-ccs.org
TELEX: MA 34199**

Figure 13. Piracy Warning with Safety priority

(Addressed to a rectangular area with SW corner is at 30°S 20°E, 60o extension to the North and 120° to the East)

LES 105 - MSG 5966 - SAR Distress Call to Area: 35+36 N 11+14 E – PosOK

**FM MRCC ROME - ITALIAN COAST GUARD
TO ALL SHIPS TRANSITING IN SICILY CHANNEL**

**IN ORDER TO PROTECT THE HUMAN LIFE AT SEA, YOU ARE KINDLY
REQUESTED TO KEEP A SHARP LOOKOUT AND TO REPORT ANY SIGHTINGS
OF BOATS WITH MIGRANTS ON BOARD TO MRCC ROME AT FOLLOWING
NUMBERS:**

**PHONE: 0039 06 59084527 / 59084409
FAX: 0039 06 5922737 / 59084793
INM-C: 424744220
EMAIL: ufficio3.reparto3@mit.gov.it**

Figure 14. Search and Rescue (SAR) coordination message with Distress priority

(Addressed to a rectangular area with SW corner is at 35°N 11°E, 36° extension to the North and 11° to the East)

LES 104 - MSG 796 - MetWarn/Fore Safety Call to Area: 4 – PosOk

**Eik LES 24-OCT-2018 11:23:36 028988
SUBJ: NORTH AMERICAN ICE SERVICE (NAIS) ICEBERG BULLETIN
ISSUED BY INTERNATIONAL ICE PATROL (IIP)**

SECURITE

**1. 24 OCT 18 1200 UTC ICEBERG LIMIT: FROM 5212N 5539W TO 5130N 5345W
TO 5130N 5200W TO 5215N 5130W TO 5300N 5130W TO 6000N 5800W.**

**2. SEA ICE LIMIT: FROM 4840N 5305W TO 5400N 5530W TO 5600N 5830W TO
5800N 5900W TO 6030N 6030W TO 6500N 5700W TO 7030N 5600W TO 6630N**

5600W TO 6230N 5130W TO 6155N 4945W AND FROM 4520N 6100W TO 4600N 5930W TO 4700N 6000W TO 5000N 6600W TO 5000N 6500W TO 4900N 6300W TO 4850N 6200W TO 4950N 6000W TO 5100N 5800W TO 4840N 5900W.

3. REPORT POSITION AND TIME OF ANY ICE ENCOUNTERED TO COMINTICEPAT VIA CG COMMUNICATIONS STATION NMF, NMN, INMARSAT CODE 42, OR ANY CANADIAN COAST GUARD RADIO STATION. MAKE UNCLASSIFIED SEA SURFACE TEMPERATURE AND WEATHER REPORTS TO COMINTICEPAT EVERY SIX HOURS WITHIN LATITUDES 40N AND 60N AND LONGITUDES 39W AND 57W.

4. NAIS RECONNAISSANCE IS FOCUSED NEAR THE GRAND BANKS OF NEWFOUNDLAND AND THE EAST COAST OF LABRADOR. ICE CONDITIONS SOUTH OF GREENLAND ARE NOT MONITORED BY NAIS.

5. ADDITIONAL ICE PRODUCTS AND A SURVEY REGARDING IIP SERVICES ARE AVAILABLE AT WWW.USCG-IIP.ORG.

Figure 15. International Ice Patrol Warning with Safety priority, NAVAREA IV

12. EGC RECEIVER TYPES

EGC SafetyNET broadcasts are received using Inmarsat C, Mini C and Fleet Safety maritime terminals of different classes. Inmarsat C and Mini C Class 2 and 3 models provide EGC capability in addition to shore-to-ship and ship-to-shore messaging capability; Class 0 are self-contained EGC receivers only. It should be noted that not all these models meet GMDSS requirements and not all non-GMDSS models support reception of MSI. Fleet Safety can receive EGC broadcasts via all FleetBroadband class terminals.

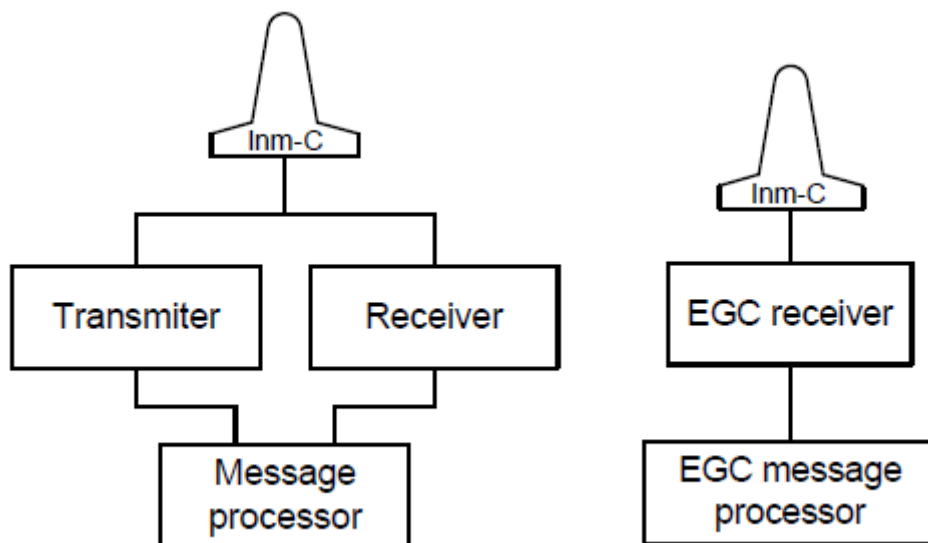

Class 0 SES (stand-alone EGC receiver)

Class 1 (no EGC receiver)

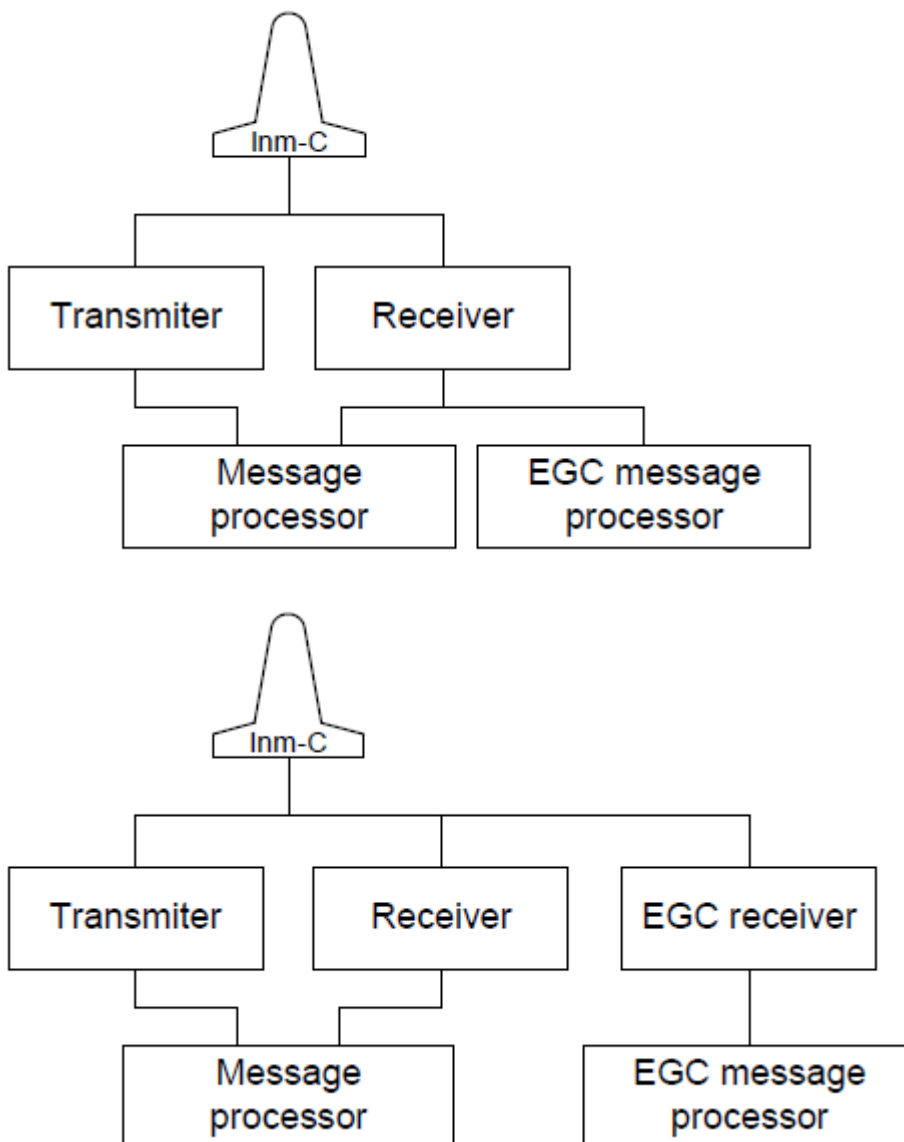

Class 2 SES (single receiver) – see note

Class 3 SES (two receivers)

Figure 16. Class of Inmarsat C and Mini-C Ship Earth Stations

Note: Majority of Maritime SESs with EGC receivers are Class 2 terminals

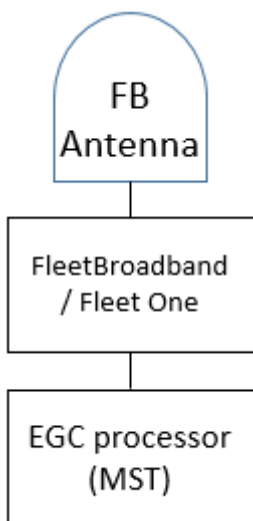

Figure 17. Fleet Safety EGC Station

13. MANAGING YOUR INMARSAT C EGC RECEIVER

This section gives the operator of an EGC receiver advice on how to set-up and use the receiver, to obtain the required results from the SafetyNET services.

The section should be read in conjunction with the manufacturer's instructions for specific information on how to do the following:

- Select a satellite/Ocean Region and log in to your preferred LES;
- Program the receiver for additional NAVAREA(s)/METAREA(s) for which to receive messages. Some models require programming for the main NAVAREA/METAREA in which the ship is navigating;
- The majority of modern EGC receivers have an automatic position update from its built in GNSS receiver. If it is not available or has failed, update the ship's position manually at least every 4 hours;
- Specify the additional types of MSI message required. It may be MSI for some fixed areas that are outside the sailing area or coastal warnings. Please refer to the next paragraph on how to configure the EGC receiver to receive coastal warnings broadcast as the EGC SafetyNET services.
- If using Inmarsat C or Mini C SES, ensure that the SES is idle (not transmitting) at the scheduled times of MSI broadcasts, as given in a current List of Radio Signals publication.

14. ADVISORY INFORMATION ON SES OPERATING PROCEDURES

To avoid possible problems, and to ensure that all mandatory MSI are recommended procedures in the manufacturer's equipment operating handbook and the procedures below should be followed:

- **Message/Archive Log:** All incoming (received and EGC messages) and outgoing (transmitted) messages are recorded on a disk in specified log files. Each log file may hold a limited number of messages (limited by disk size or PC storage

capacity). When the free disk space falls below a certain size, the terminal will display a warning message asking to allocate additional memory.

- **Message Routing:** Check the message routing option on the terminal. Incoming messages should be routed to at least one of the output media - disk or printer. EGC SafetyNET messages with Urgency and Distress priority will be stored on the disk and printed out automatically, if a printer is installed. EGC SafetyNET messages with Safety priority can be printed out automatically too (user option), otherwise they will be stored on the disk. Reception of MSI is mandatory on SOLAS compliant SESs and cannot be deactivated.
- **EGC SafetyNET set-up:** Ensure that you are logged into the appropriate satellite for the scheduled MSI that you need to receive. Ensure your NAVAREA/METAREA is selected and any adjacent areas you wish to receive EGC for, consult manufacturers handbook on how to do this. Timetables of broadcast and nominated satellites can be found in various national/international publications, such as Admiralty List of Radio Signals and table 2 & 3 above.
- If accurately set-up, your SES will automatically receive current and all relevant adjacent NAVAREAs/METAREAs MSI messages. If you require additional MSI for adjacent area(s), you must programme your terminal to receive this information.
- **EGC only option:** Be careful if using the "EGC only" or "EGC only receiver" option. If this option is selected, the terminal will, effectively, be logged out and you will not be able to receive normal messages (mail) on your terminal. Also, if you choose "EGC only", previous EGC settings may be ignored and the terminal may receive all EGC messages within the Ocean Region.
- **Configuration of the Inmarsat C or Mini C mobile terminal:** If the Inmarsat C or Mini C terminal is used for communication (not as a supervisory control and data acquisition (SCADA) or "black box" terminal), it MUST have a DTE terminal which includes a keyboard, visual display unit or messaging unit and printer. Every mobile terminal, if properly configured, set-up and maintained, will automatically receive and print out all relevant messages addressed to it. These messages will be displayed, printed, stored, or both. Improper settings, including printer settings, not in accordance with the manufacturer's instructions, will degrade the performance. **In addition, the installation of a "black box" option, with no display or keyboard is not condoned by Inmarsat or the IMO and could cause unnecessary disruption to Rescue Coordination Centres.**

15. REDUCE THE NUMBER OF ALARMS

The receiver is programmed to provide an audible/visual alarm on receiving MSI with distress or urgency messages, which should be responded to immediately. To make sure that no unnecessary alarms are received, the following steps should be taken:

Keep the ship's position updated, to ensure that the receiver rejects messages for any geographic areas which do not include the ship's position;

It is strongly recommended that automatic update of positioning information is used whenever available on terminals without a built-in GNSS receiver, by using a satellite position input on navigational interface.

16. MANDATORY MSI MESSAGES

Under SOLAS requirements (as well as for the safety of all aboard), receipt of the following types of EGC SafetyNET MSI messages is mandatory:

- Shore-to-ship distress alert relays for circular areas, if your position is contained within such an area;
- Navigational, meteorological or piracy warnings addressed to a circular or rectangular area, if your position is contained within such an area;
- Search and Rescue coordination to a circular or rectangular area, if your position is contained within such an area;
- NAVAREA warnings for the current NAVAREA;
- METAREA warnings or forecasts for the current METAREA.

17. ADDITIONAL RECOMMENDED MSI MESSAGES

In addition to the receiving the above mandatory message types, IMO recommends that it's also programmed to receive the following messages:

- MSI for any other NAVAREAs/METAREAs in which the ship is planned to sail. Note that additional NAVAREAs/METAREAs specified do not need to be adjacent to the current area but be aware of the satellite used for MSI broadcast for additional area(s).
- Coastal warning for areas where the service is available and if Inmarsat C or Mini C SES is programmed with appropriate B1, B2 codes.

18. GOOD OPERATING PRACTICE

The following advice is given for the best possible use of the SafetyNET services:

- Ensure any equipment associated with the EGC receiver is working properly, as indicated in the manufacturer's instructions, and that the printer is loaded with paper and print cartridges.
- Make sure the Inmarsat C or Mini C terminal is monitoring the appropriate satellite/Ocean Region at the time of a scheduled broadcast.
- Make sure that the terminal is not storing unwanted messages and has storage space for new messages.
- Consider printing in a small font, to reduce the amount of paper used for messages (depending on printer model/options).
- Regularly check and confirm your current position on the terminal is correct and updated, as explained in the previous sections.
- Enter all NAVAREAs/METAREAs and coastal areas on the terminal, for which you want to receive MSI, considering your intended voyage. Also, enter the Coastal types of warning message you want to receive, reject, and any unwanted types.
- If possible while in port, keep the EGC receiver in operation, to ensure that you have received all necessary MSI before sailing.
- To find the time of scheduled MSI broadcasts, refer to the current "List of Radio Signals" obtainable from national administrations. At the scheduled time, make sure that the receiver is tuned to the appropriate channel/Ocean Region, as shown in Figures 1-4.
- If using and Inmarsat C or Mini C, when sailing from one Ocean Region to another region, ensure that the terminal is manually "logged in" to the new region when it is required. An alarm will sound when synchronisation has been lost due to vessel sailing out of coverage of an Ocean Region. Manual "logging in" to the new Ocean Region will automatically cause the system to "log the SES" out of the previous Ocean Region. Please note that an automatic logging in to the new ocean regions

with a stronger satellite signal is not allowed on SOLAS compliant SESs and it should be done manually.

- Throughout your voyage, ensure that a written log is kept of the identities of all received messages, and a printed copy is kept of all distress traffic. Other messages should be kept on the bridge for as long as they remain in force.
- What to do about missed messages. If you think you have missed any messages, for example at a scheduled broadcast time, you can switch the terminal off and on again - this will clear the internal memory of all stored message IDs, if the message is re-broadcast, your receiver will automatically receive the message.

19. REGULAR POSITION UPDATES

Your EGC receiver **MUST** be updated regularly with the ship's position if automatic GNSS updates is not provided on older models.

The reasons for updating your EGC receiver regularly with the ship's position include:

- Only receive and print messages for the area where this ship is navigating - if the ship's position has not been updated for 4 hours (depending on the model), the receiver will automatically print or store all geographically addressed messages within the entire Ocean Region;
- To decide if the receiver should receive and print a message addressed to additional geographic areas;
- Most importantly, if you are in distress, the correct position will be essential for any distress alerts you send.

Two ways are available to update a terminal with the ship's position:

- **Automatically**, using a built-in GNSS receiver; most modern SES models now contain an integrated GNSS receiver, whilst older models may be interconnected to a separate onboard GNSS receiver.
- **Manually**, by keying position coordinates directly into the terminal; IMO requires this is done every four hours, otherwise you will receive and print ALL EGC SafetyNET messages broadcast via the satellite.

Another important reason for updating the terminal regularly with the ship's position, while not directly related to the SafetyNET services, is to ensure that the correct position is given if a Distress alert has to be sent.

20. HOW TO SET UP AN EGC RECEIVER TO RECEIVE COASTAL WARNINGS

Inmarsat C and Mini C terminal receive all EGC messages on the broadcast channel, however some messages can be suppressed from being displayed and printed automatically.

All SafetyNET messages addressed to NAVAREAs/METAREAs, rectangular and circular areas are mandatory and will be received automatically for reception if the ship's position is inside the addressed area. *Note: some older models require manual set-up of the main NAVAREA/METAREA where the ship is navigating in order to receive this information automatically. Newer models automatically recognise the main NAVAREA/METAREA.*

Manual EGC set-up is required to receive coastal warnings that involves programming appropriate B1, B2 codes as shown in Figure 18 below.

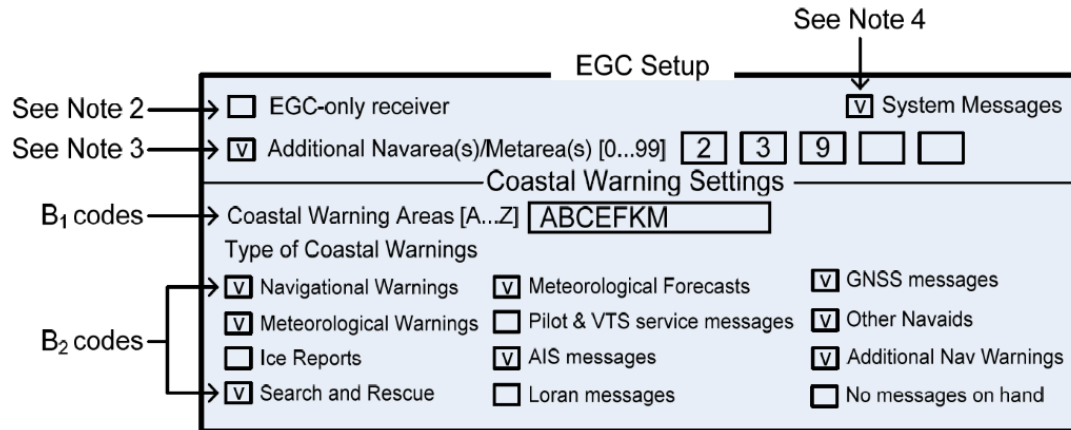

Figure 18. General overview of EGC set-up screen

MSI providers address coastal warnings using 4-digit format – X1X2B1B2, where X1X2 is NAVAREA/METAREA number (two digits) in the range 01 - 21 (see Note 1 below), B1 – coastal warning area A – Z within the main NAVAREA/METAREA, B2 – subject indicator (or message type) A - Z:

- A - Navigational warnings;
- B - Meteorological warnings;
- C - Ice reports;
- D - Search and rescue information, acts of piracy warnings, tsunami and other natural phenomena;
- E - Meteorological forecasts;
- F - Pilot and VTS service messages;
- G - AIS service messages (non-navigational aid);
- H - LORAN system messages;
- J - GNSS messages;
- K - Other electronic navigational aid messages;
- L - Other Navigational warnings (additional to Navigational warnings); and
- Z – No messages on hand.

Note 1: EGC Coastal warning service is not supported within all NAVAREAs/METAREAs. Please refer to the current publication of Lists of Radio Signals, available from national administrations.

Main and/or additional NAVAREAs/METAREAs, B1B2 codes are set up on Inmarsat C and Mini C terminals via the EGC Setup screen, a general configuration of the screen is shown in Figure 18. Please remember that both B1 and B2 codes should be set-up. It should be noted that configuration of the EGC set-up screen varies between different Inmarsat C and Mini C models and the Figure above gives only a general overview, however EGC set-up functions are the same for all models.

Note: “System Messages“ option is used to set-up the terminal to receive Inmarsat “System” type EGC messages, giving information about Inmarsat systems, planned outages, new services, etc.

21. EGC SAFETYNET LOG

All Inmarsat C and Mini C terminals that support EGC services have an EGC log, example of this log is in Figure 20.

MESSAGE NUMBER	LES	SERVICE	PRIORITY	DATE & TIME RECEIVED	SIZE	SEQUENCE NUMBER	ROUTING
20022405.egc	321	MET/NAV warning/forecast	Safety	20-02-24 03:31	2263	1605	Mem
20022402.egc	321	SAR coordination	Urgency	20-02-24 03:02	1506	1604	Prn+Mem
20022401.egc	322	Coastal warning/forecast	Safety	20-02-23 02:56	269	9154	Mem
20022302.egc	304	Distress alert relay	Distress	20-02-23 20:44	769	691	Prn+Mem
20022305.egc	317	NAV warning	Safety	20-02-23 19:41	819	8318	Mem
20022302.egc	322	MET warning	Safety	20-02-23 19:35	2358	9150	Mem

Figure 19. General overview of EGC log

The EGC log contains the following information on all EGC message received by the terminal:

- Message number – generated by the terminal;
- LES – number of the addressed LES;
- Service – type of EGC messages;
- Priority – priority of the message – Safety, Urgency or Distress;
- Rec Date & Time – the date/time when the message was received;
- Size – message size in number of bytes or characters;
- Seq. no. – the unique message sequence number given to the message by the addressed LES; and
- Routing – message routing – memory or memory + printer – set up by the ship’s operator. For SOLAS compliant MESs routing to memory + printer is mandatory for
- Urgency and Distress priority messages.

It should be noted that configuration of the EGC log screen varies between different Inmarsat C and Mini C models and the Figure above gives only a general overview, however the EGC data is the same for all models.

22. MANAGING THE INMARSAT FLEET SAFETY EGC RECEIVER

Inmarsat Fleet Safety is the newest GMDSS offering from Inmarsat, providing current and enhanced safety services including EGC retrieval.

Fleet Safety consists of an Inmarsat FleetBroadband and a connected Maritime Safety Terminal (MST). This provides all satellite GMDSS services including EGC reception of SafetyNET services.

Because Fleet Safety uses the new advanced Inmarsat Safety services, there is no requirement for the operator to change satellites for reception of EGC broadcasts. ALL EGC broadcasts are receivable over any satellite covering the broadcast area.

Configuration of the Fleet Safety terminal:

MSI Parameters

Areas Select adjacent areas

Types Select types

Service Codes Select service codes

Confirm Settings

Receive MSIs from adjacent areas

<input checked="" type="checkbox"/> Area I (United Kingdom)	<input checked="" type="checkbox"/> Area II (France)	<input checked="" type="checkbox"/> Area III (Spain)
<input type="checkbox"/> Area IV (United States (East))	<input type="checkbox"/> Area V (Brazil)	<input type="checkbox"/> Area VI (Argentina)
<input type="checkbox"/> Area VII (South Africa)	<input type="checkbox"/> Area VIII (India)	<input type="checkbox"/> Area IX (Pakistan)
<input type="checkbox"/> Area X (Australia)	<input type="checkbox"/> Area XI (Japan)	<input type="checkbox"/> Area XII (United States (West))
<input type="checkbox"/> Area XIII (Russian Federation)	<input type="checkbox"/> Area XIV (New Zealand)	<input type="checkbox"/> Area XV (Chile)

< Previous Next > Cancel

“Receive MSIs from adjacent areas” allows the user to select adjacent areas to receive MSI from. If this is not selected, you will receive MSI for current area only.

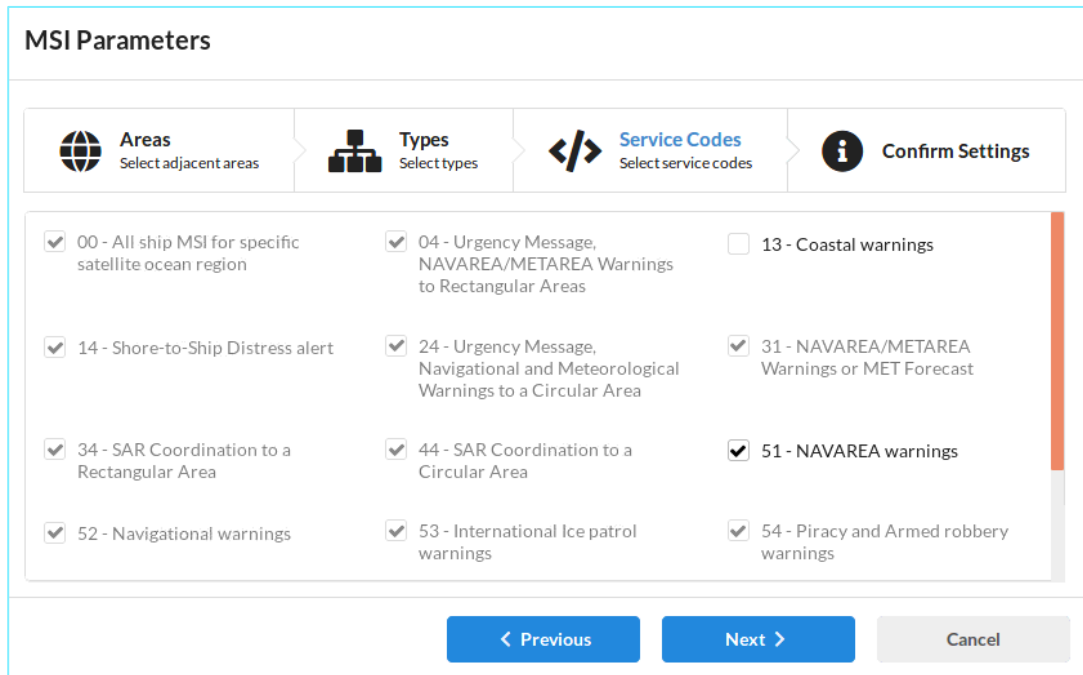

Figure 20 Fleet Safety MSI Pull (i)

The user can select messages they want to receive, some message types cannot be removed and must be received.

- **EGC Retrieval**

The Fleet Safety terminal enables the user to search for EGC broadcasts they may have missed due to the terminal being turned off i.e. in port.

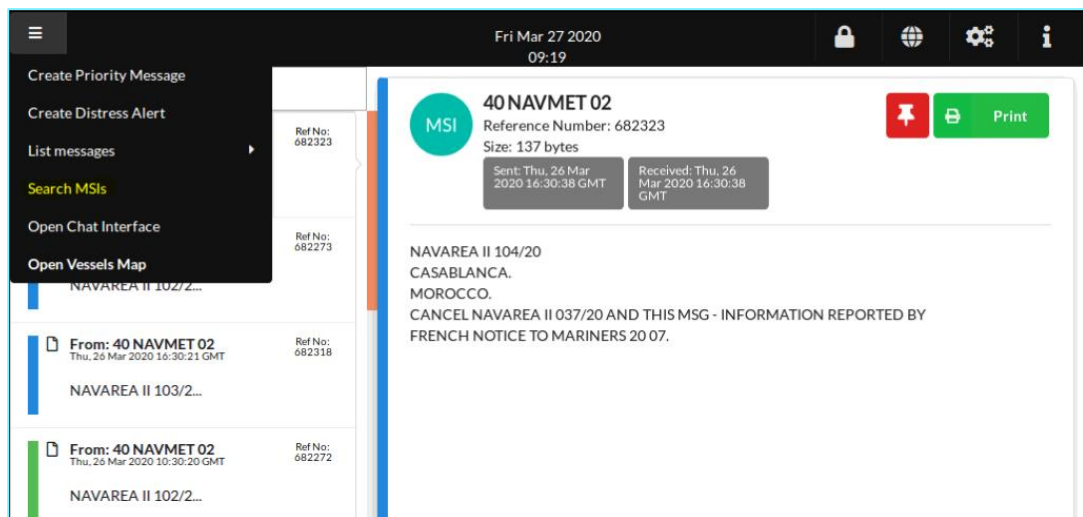

Figure 21 Fleet Safety MSI Pull (ii)

Select “Search MSIs”

The screenshot shows a web interface titled "Request MSI". At the top, there are three steps: "Search" (Select search parameters), "Select MSIs" (Select MSIs to pull), and "Confirm request". The "Search" step is active. Below the steps, there are four input fields: "Address Type" (NAVNET), "Address" (I - United Kingdom), "Start Date" (March 17, 2020 0:00), and "End Date" (March 27, 2020 9:21 AM). At the bottom, there are three buttons: "Previous", "Next", and "Cancel".

Figure 22 Fleet Safety MSI Pull (iii)

Select NAV/METAREA, Start Date and time, End Date and time, to search for EGC messages that may not have been received.

This provides a list of EGC messages that have not been received on Fleet Safety. The user can choose to download these messages directly onto the Fleet Safety system. Messages already received are displayed in grey and cannot be redownloaded.

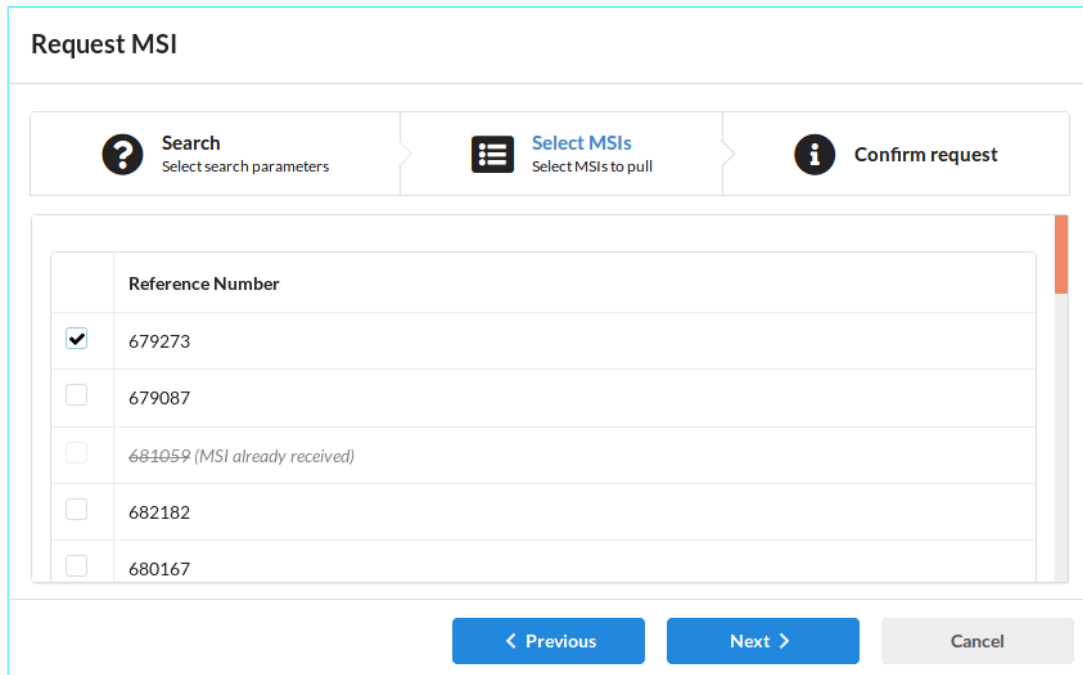

Figure 23 Fleet Safety MSI Pull (iv)

Select the message to be download and click “Next” to download.

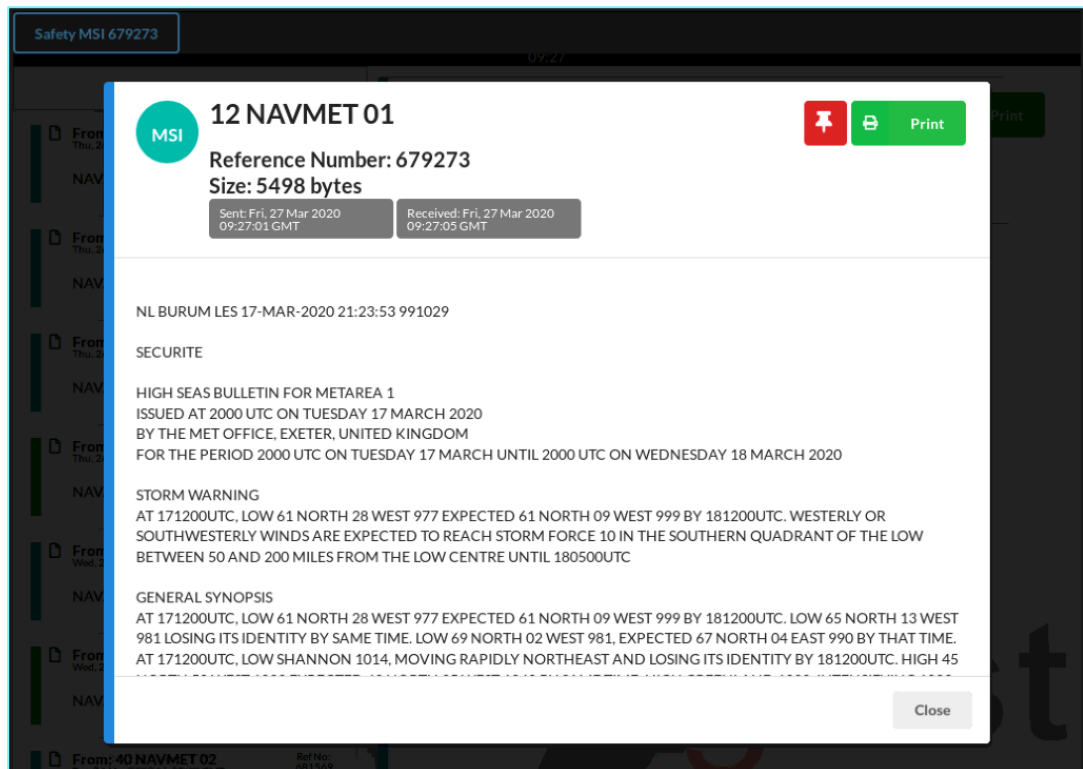

Figure 24 Fleet Safety MSI Pull (v)

Message is displayed and stored on your Fleet Safety terminal.

23. WHO TO CONTACT FOR ADVICE

Further information about SafetyNET can be obtained from the following sources:

- The International SafetyNET Manual, obtainable from IMO at the address given in Annex B.
- The Master Plan of Shore-based Facilities for the GMDSS, obtainable from IMO.
- Current Lists of Radio Signals, obtainable from national administrations.

For general advice on the SafetyNET services, contact the Chairman of the International SafetyNET Broadcast Co-ordinating Panel, at the address given in Annex B.

For general advice on the Inmarsat satellite networks, contact Inmarsat on the details provided in Annex B.

ANNEX A – OPERATIONAL OVERVIEW OF SAFETYNET (II)

Operation of the SafetyNET Service - an overview

Operation of the SafetyNET service, illustrated in Figure 6, involves a sequence of events:

A NAVAREA / METAREA Coordinator will receive information vital to shipping from its approved source, such as a National Hydrographic Office or Meteorological Office. The approved messages will then be sent to the MSI Provider.

Each MSI Provider prepares an EGC broadcast in a standardised format and submits it to the SafetyNET service via an Inmarsat LES or SafetyNET II. Included with the message are the parameters, known as the "C" codes, to instruct the Inmarsat network and EGC receiver on how to process the message automatically:

- C0 - Ocean Area Code. Identifies which Inmarsat satellite the MSI is addressed to (generally the code is used by LESs supporting service in two or three ocean regions);
- C1 - Priority Code. Identifies the message priority – Distress - P3, Urgency – P2 and Safety – P1;
- C2 - Service Code. Identifies the message type, for example a shore-to-ship distress alert, or meteorological forecast;
- C3 - Address Code. Identifies the geographical area for which the MSI is applicable – this may be a fixed geographical area, such as one of the 21 NAVAREAs/METAREAs shown in Figure 2, a temporary area determined by the MSI provider, such as a circular or rectangular area, as shown in Figure 5 and Figure 6 or a coastal warning area;
- C4 - Repetition Code. Indicates the number of times the message should be broadcast unless cancelled;
- C5 - Presentation Code. Indicates the character set in which the message will be transmitted. The character set used is always International Alphabet Number 5, which is also known as 7-bit ASCII.

The MSI provider uses the scheduled time(s) at which the message is to be broadcast and the satellite to be used.

The Inmarsat system will broadcast the message at the schedule time and with the priority set.

The NCS / SAS automatically broadcasts the message on the common signalling channel over the entire Ocean Region. All EGC receivers within the Ocean Region will receive the message, however, only EGC receivers in the addressed area will accept and display the message.

If a message has a repetition code set, it will rebroadcast at the set intervals. The EGC receiver will only receive the message once and will reject repeated messages, unless the original message has been deleted from the EGC receiver.

Operation of the SafetyNET II Service - an overview

Operation of the SafetyNET II service, illustrated in Figure 7, involves the same sequence of events as with SafetyNET up to the point the Coordinator is ready to broadcast the message.

The coordinator uses a secure web interface to compose the MSI message, utilising the interactive user options and settings. These options and settings automatically encode the “C codes” into the MSI and broadcast direct to the Network Coordination Station (NCS) and Satellite Access Station (SAS), ready to be broadcast over the common signalling channel at the annotated broadcast time for automatic reception on EGC enabled Inmarsat C, Mini C and Fleet Safety terminals.

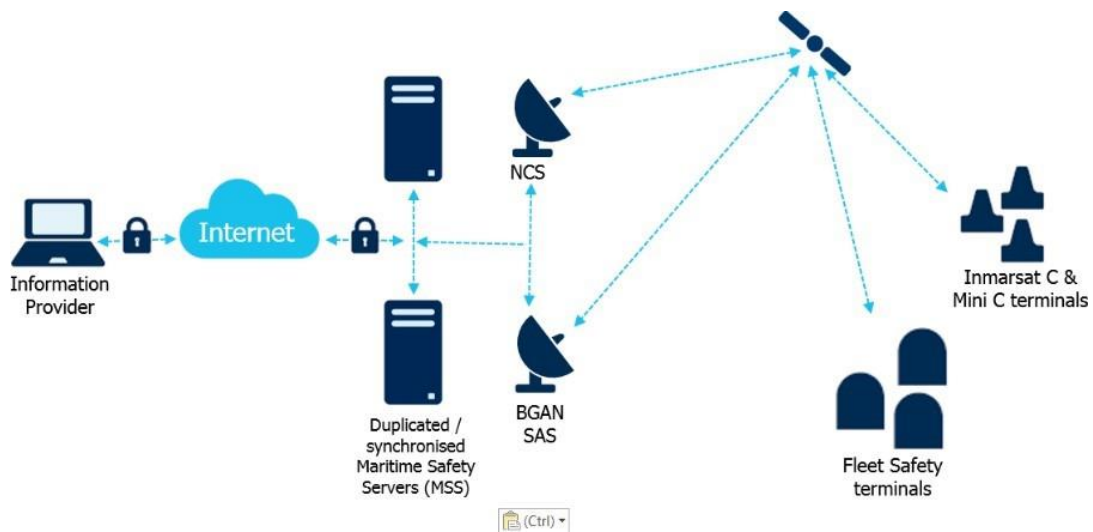

Figure 25 International SafetyNET II service

ANNEX B – SAFETYNET CONTACTS

For general information on the International SafetyNET service contact:

The Chair, IMO Enhanced Group Call Coordinating Panel
International Maritime Organisation
4 Albert Embankment
London, SE1 7SR
United Kingdom

Telephone: +44 (0)20 7735 7611

Fax: +44 (0)20 7587 3210

Email: ncsr@imo.org
(in subject line add: "for Chair, IMO Enhanced Group Call Coordinating Panel")

To purchase IMO publications, contact:

IMO Publishing
4 Albert Embankment
London, SE1 7SR
United Kingdom
☎ +44 (0)20 7735 7611
✉ sales@imo.org

For general information on Inmarsat satellite services, contact Inmarsat Global Customer Support:

Global Customer Support
Inmarsat Global Ltd.
99 City Road
London, EC1 1AX
United Kingdom

☎ +1 800-563-2255 (Toll free in N. America)
☎ +1 709-748-4226 (Worldwide)
☎ 33# (Toll free when dialled from handset (does not apply to pre-paid mobile))
✉ globalcustomersupport@inmarsat.com
📠 Fax: 1 877-748-4320 (Toll free in N. America) / +1 709-748-4320 (Worldwide)

Our Global Customer Support is available 24 hours/365 days a year.

Information is also available on www.inmarsat.com.

You may also access a directory of IMNs (Inmarsat Mobile Numbers) for a particular vessel via this link: www.inmarsat.com/ships-directory/

Specific information on Inmarsat Maritime Safety Services and Inmarsat's role within the GMDSS, can be found online at: www.inmarsat.com/safety, or by contacting the Inmarsat Maritime Safety Services team on maritime.safety@inmarsat.com.

ANNEX C – PERFORMANCE STANDARDS FOR EGC EQUIPMENT

Annex to IMO Resolution MSC.306(87) 2010: Revised Performance Standards for Enhanced Group Call (EGC) Equipment.

INTRODUCTION

The Enhanced Group Call equipment (EGC) to be used in the GMDSS should comply with the general requirements set out in Assembly resolution A.701(17), IEC 61097-4 and IEC 60945 and the following minimum performance requirements.

The equipment should be capable of producing a printed copy of received information. Received EGC messages may be stored for later printing, with an indication to the operator that the message has been received except for the vital messages referred to in paragraph 3.2 which should be printed out upon receipt.

The EGC installation may be either separate or combined with other installations.

TECHNICAL REQUIREMENTS

The equipment should be type approved by Inmarsat and should comply with the environmental conditions and electromagnetic compatibility requirements specified in IEC 60945.

OPERATION

The equipment should provide a visual indication that the ship's position has not been updated during the last 12 hours. It should only be possible to reset this indication by revalidating the ship's position.

Means should be provided to enter the ship's position and current and planned NAVAREA/METAREA codes manually so that area group calls can be received. Means should also be provided to enter current and planned coastal warning service coverage areas and different classes of messages. Optionally, the ship's position, as determined by the navigational equipment, may be entered automatically and the NAVAREA/METAREA code automatically derived therefrom.

Provision should be made for a specific aural alarm and visual indication at the position from which the ship is normally navigated, to indicate receipt of a distress or urgency priority EGC message. It should not be possible to disable this alarm and it should only be possible to reset it manually and only from the position where the message is displayed or printed.

The equipment should indicate when it is not correctly tuned or synchronised to the EGC carrier.

Any message should be printed regardless of the character error rate of its reception. The equipment should print a low line mark if a character is received corrupted.

Acceptance or rejection of service codes should be under the operator's control, except that equipment should always receive navigational warnings, meteorological warnings and forecasts, search and rescue information and shore-to-ship distress alerts, which are directed to a fixed or absolute geographical area within which the ship is operating.

Means should be provided to prevent the reprinting of a message once it has been received without error.

The printing device should be capable of printing at least the standard International Alphabet Number 5 (IA5) character set. Other character sets are optionally used according to ISO 20223 standards or ITU-T Recommendation T.61.

The printing device should be able to print at least 40 characters per line.

The signal processor and printing device should ensure that if a word cannot be accommodated in full on one line, it should be transferred to the next line. The printing device should automatically feed five lines after completing the printed messages.

A local audible alarm should be sounded to give advanced warning of the printing device “paper low” condition. It should not be possible to confuse the sound of the “paper low” alarm with that of the distress or urgency alarm caused by the reception of a distress or urgency priority message.

SOURCES OF ENERGY

The EGC equipment should normally be powered from the ship's main source of electrical energy. In addition, it should be possible to operate the EGC equipment, and all other equipment necessary for its normal functioning, from an alternative source of energy.

Changing from one source of supply to another, or any interruption of up to 60 seconds duration of the supply of electrical energy, should not require the equipment to be manually reinitialized and should not result in loss of received messages stored in the memory.

ANTENNA SITING

Where an omnidirectional antenna is used, it is desirable that the antenna be sited in such a position that no obstacle likely to degrade significantly the performance of the equipment appears in the fore and aft directions down to -5° and in the port and starboard directions down to -15° .

Where a stabilized directive antenna is used, it is desirable that the antenna be sited in such a position that no obstacle likely to degrade significantly the performance of the equipment appears in any azimuth down to -5° .

For omnidirectional antennas, objects, especially those within 1m of the antenna, which cause a shadow sector of greater than 2° , are likely to degrade significantly the performance of the equipment.

For directive antennas, objects, especially those within 10 m of the antenna, which cause a shadow sector of greater than 6° , are likely to degrade significantly the performance of the equipment

1. *Elements of other installations, e.g. the antenna, low noise amplifier and down-converter of the ship earth station, may be shared for the reception of EGC messages.*
2. *The meaning of the service codes is in accordance with the Recommendation ITU-R M.540-2 1990, Operational and technical characteristics for an automated direct-*

printing telegraph system for promulgation of navigational and meteorological warnings and urgent information to ships.

3. *Note: ISO 2022, "Information technology – Character code structure and extension techniques" standards.*